



Nitric Oxide Gas Sensor NO/VF-300-4E

NO Gas Sensor in Vantage Housing

Key Features

- Replaceable Filter
- Operable in Harsh Conditions with Temperatures up to 60°C

Applications

- Stack/ Flue Gas Monitoring
- Emission Monitoring

Measurement

Operation Principle	4-Electrode Electrochemical
Nominal Range	0 - 300 ppm
Maximum Overload	600 ppm
Inboard Filter	To remove effect of SO ₂
Output Signal	500 ± 80 nA/ppm
Resolution (Electronics dependent)	< 0.2 ppm
T90 Response Time	< 36 s
Typical Baseline Range (pure air, 20°C)	0.0 ppm to 3.0 ppm ¹⁾
Maximum Zero Shift (+20°C to +40°C)	7 ppm
Repeatability	< 2 % of signal
Output Linearity	Linear
Gain (Only applies to 4-Electrode sensors)	N.D.

Performance data recorded at 20 – 25 °C, 30 - 50% RH, 900 - 1100 mbar

For further information about usage of Membrapor sensors, see application note [MEM1](#). The data contained in this document is for guidance only. Membrapor AG accepts no liability for any consequential losses, injury or damage resulting from the use of this document or from any omissions or errors herein. Customers should test under their own conditions to ensure that the sensors are suitable for their own requirements.



Nitric Oxide Gas Sensor NO/VF-300-4E

Electrical

Rec. Load Resistor	10 - 33 Ω
Bias ($V_{Sens}-V_{Ref}$)	+300 mV
Conformity to RoHS directive	RoHS Compliance

Environmental

Relative Humidity Range	15 % to 90 % RH non-condensing
Temperature Range	-40 °C to 60 °C
Pressure Range	Atmospheric
Pressure Coefficient	N.D.
Humidity Effect	None

Lifetime

Expected Operation Life	3 years in air
Expected Long Term Output Drift in air	< 2 % signal loss per month
Filter Life	10'000 ppm hours
Storage Life	6 months in container
Rec. Storage Temperature	5°C - 20°C
Warranty Period	12 months from date of dispatch

Performance data recorded at 20 – 25 °C, 30 - 50% RH, 900 - 1100 mbar

For further information about usage of Membrapor sensors, see application note [MEM1](#). The data contained in this document is for guidance only. Membrapor AG accepts no liability for any consequential losses, injury or damage resulting from the use of this document or from any omissions or errors herein. Customers should test under their own conditions to ensure that the sensors are suitable for their own requirements.



Nitric Oxide Gas Sensor NO/VF-300-4E

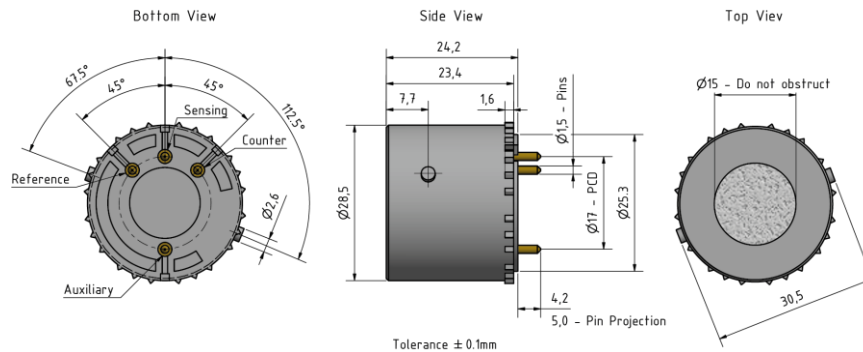

Mechanical

Weight	16 g
Orientation	Any
Housing material	Polycarbonate

Performance data recorded at 20 – 25 °C, 30 - 50% RH, 900 - 1100 mbar

For further information about usage of Membrapor sensors, see application note [MEM1](#). The data contained in this document is for guidance only. Membrapor AG accepts no liability for any consequential losses, injury or damage resulting from the use of this document or from any omissions or errors herein. Customers should test under their own conditions to ensure that the sensors are suitable for their own requirements.



Nitric Oxide Gas Sensor NO/VF-300-4E

Cross Sensitivity Data

The table below does not claim to be complete. We recommend using the target gas for calibration purposes. Using surrogate (interfering) gases can result in inaccuracies in the final calibration. Please contact Membrapor AG for further support regarding cross sensitivities.

Interfering Gas	Cross-Sens. [%]
CO	0
H ₂	0
H ₂ S	0
NO ₂	< 15
SO ₂	0

Performance data recorded at 20 – 25 °C, 30 - 50% RH, 900 - 1100 mbar

For further information about usage of Membrapor sensors, see application note [MEM1](#). The data contained in this document is for guidance only. Membrapor AG accepts no liability for any consequential losses, injury or damage resulting from the use of this document or from any omissions or errors herein. Customers should test under their own conditions to ensure that the sensors are suitable for their own requirements.