



## Formaldehyde Gas Sensor CH2O/CA-10

CH2O Gas Sensor in Compact Housing

### Key Features

- Highly selective CH2O measurement

### Applications

- Continuous Air Quality Monitoring
- Safety and Environmental Control

### Measurement

Operation Principle	3-Electrode Electrochemical
Nominal Range	0 - 10 ppm
Maximum Overload	20 ppm
Inboard Filter	-
Output Signal	1500 ± 500 nA/ppm
Resolution (Electronics dependent)	< 0.03 ppm
T60 Response Time	< 90 s
Typical Baseline Range (pure air, 20°C)	0.0 ppm to 1.0 ppm
Maximum Zero Shift (+20°C to +40°C)	N.D.
Repeatability	< 2 % of signal
Output Linearity	Linear
Gain (Only applies to 4-Electrode sensors)	-

#### **Performance data recorded at 20 – 25 °C, 30 - 50% RH, 900 - 1100 mbar**

For further information about usage of Membrapor sensors, see application note [MEM1](#). The data contained in this document is for guidance only. Membrapor AG accepts no liability for any consequential losses, injury or damage resulting from the use of this document or from any omissions or errors herein. Customers should test under their own conditions to ensure that the sensors are suitable for their own requirements.



### Formaldehyde Gas Sensor CH2O/CA-10

#### Electrical

Rec. Load Resistor	10 - 33 $\Omega$
Bias (V_Sens-V_Ref)	+ 200 mV
Conformity to RoHS directive	RoHS Compliance

#### Environmental

Relative Humidity Range	15 % to 90 % RH non-condensing
Temperature Range	-40 °C to 50 °C
Pressure Range	Atmospheric $\pm$ 10%
Pressure Coefficient	N.D.
Humidity Effect	None

#### Lifetime

Expected Operation Life	3 years in air
Expected Long Term Output Drift in air	< 2 % signal loss per month
Filter Life	-
Storage Life	6 months in container
Rec. Storage Temperature	5°C - 20°C
Warranty Period	12 months from date of dispatch

#### **Performance data recorded at 20 – 25 °C, 30 - 50% RH, 900 - 1100 mbar**

For further information about usage of Membrapor sensors, see application note [MEM1](#). The data contained in this document is for guidance only. Membrapor AG accepts no liability for any consequential losses, injury or damage resulting from the use of this document or from any omissions or errors herein. Customers should test under their own conditions to ensure that the sensors are suitable for their own requirements.



### Formaldehyde Gas Sensor CH2O/CA-10

#### Compact-Size Outline Dimensions

BOTTOM VIEW

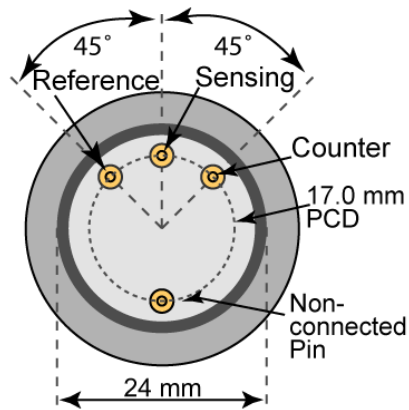

± 0.10 mm

SIDE VIEW



#### Mechanical

Weight	13 g
Orientation	Any
Housing material	Polycarbonate

#### Performance data recorded at 20 – 25 °C, 30 - 50% RH, 900 - 1100 mbar

For further information about usage of Membrapor sensors, see application note [MEM1](#). The data contained in this document is for guidance only. Membrapor AG accepts no liability for any consequential losses, injury or damage resulting from the use of this document or from any omissions or errors herein. Customers should test under their own conditions to ensure that the sensors are suitable for their own requirements.



## Formaldehyde Gas Sensor CH2O/CA-10

### Cross Sensitivity Data

The table below does not claim to be complete. Interfering gases should not be used for calibration. Please contact Membrapor AG for further support regarding cross sensitivities.

Interfering Gas	Concentration [ppm]	Reading [ppm]
CO	100	< 1
Methanol (CH <sub>3</sub> OH)	960	< 0.1

#### **Performance data recorded at 20 – 25 °C, 30 - 50% RH, 900 - 1100 mbar**

For further information about usage of Membrapor sensors, see application note [MEM1](#). The data contained in this document is for guidance only. Membrapor AG accepts no liability for any consequential losses, injury or damage resulting from the use of this document or from any omissions or errors herein. Customers should test under their own conditions to ensure that the sensors are suitable for their own requirements.